

Pressure relief valves type AGAM

two stage, subplate mounting - ISO 6264 size 10, 20 and 32

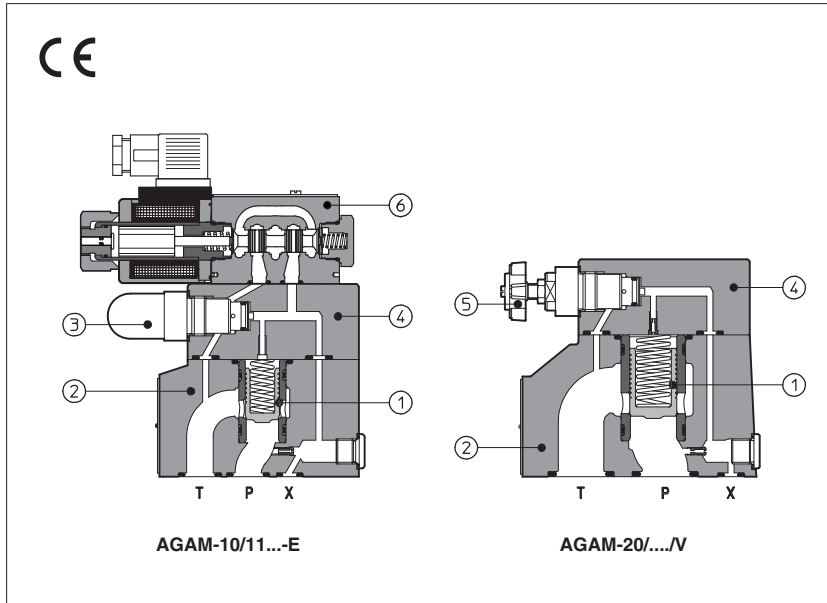

AGAM are two stage pressure relief valves with balanced poppet, designed to operate in oil hydraulic systems.

In standard versions the piloting pressure of the poppet (1) of the main stage (2) is regulated by means of a grub screw protected by cap (3) in the cover (4).

Optional versions with setting adjustment by handwheel (5) instead of the grub screw are available on request.

Clockwise rotation increases the pressure.

AGAM can be equipped with a pilot solenoid valve (6) for venting or for different pressure setting type:

- DHI for AC and DC supply, with **cURus** certified solenoids
- DHE for AC and DC supply, high performances with **cURus** certified solenoids

Mounting surface: **ISO 6264 size 10, 20 and 32**

Max flow: **200, 400 and 600 l/min**

Max pressure up to **350 bar**

1 MODEL CODE

AGAM	-	20	/	20	/	210	/	100/100	/	V	-	I	X	24DC	**	/	*
<p>AGAM = pressure relief valve subplate mounting</p> <p>Size: 10 20 32</p> <p>Setting pressure and venting option: - = one setting pressure without option 10 = one setting pressure with venting, with de-energized solenoid 11 = one setting pressure with venting, with energized solenoid 20 = two setting pressure with venting, with de-energized solenoid 21 = two setting pressure with venting, with energized solenoid 22 = two setting pressure without venting 32 = three setting pressure without venting</p> <p>Setting: see section 3 for available setting (1)</p> <p>Pressure range of second/third setting (1): 50 = 4÷50 bar 100 = 6÷100 bar 210 = 7÷210 bar 350 = 8÷350 bar</p> <p>Options, see section 5 E V WP Y</p> <p>X = without connector (1): See section 7 for available connectors, to be ordered separately -00 = solenoid valve without coils (for -I) -00-AC = AC solenoid valve without coils (for -E) -00-DC = DC solenoid valve without coils (for -E)</p> <p>Pilot valve (1): I = DHI for AC and DC supply, with cURus certified solenoids E = DHE for AC and DC supply, high performances with cURus certified solenoids</p> <p>Seals material, see section 4: - = NBR PE = FKM BT = HNBR</p> <p>Series number</p> <p>Voltage code, see section 8 (1):</p>																	

For **PED** version see technical table CY066

(1) Only for AGAM with solenoid valve for venting and/or for the selection of the setting pressure

2 HYDRAULIC SYMBOLS

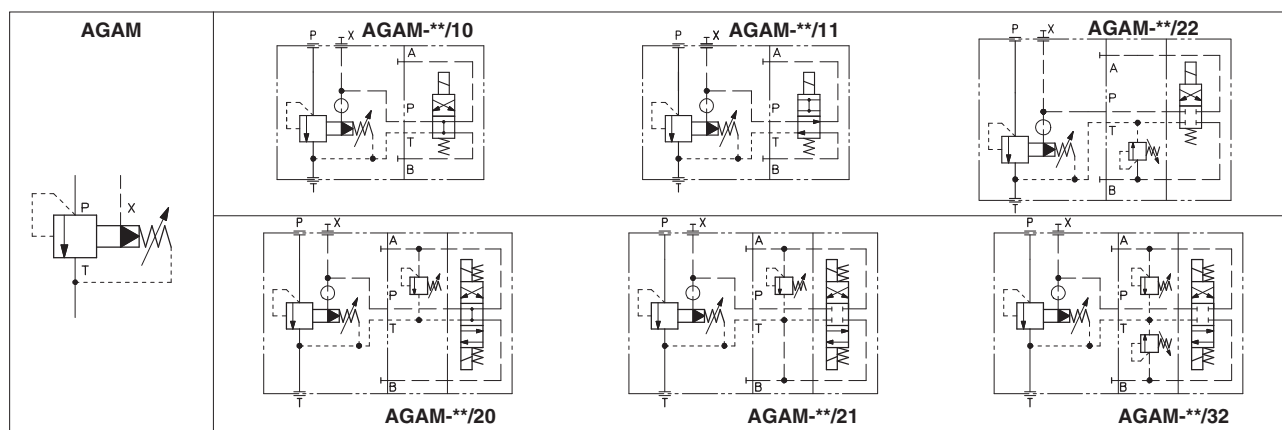

3 HYDRAULIC CHARACTERISTICS

Valve model	AGAM-10	AGAM-20	AGAM-32
Setting [bar]	50; 100; 210; 350		
Pressure range [bar]	4÷50; 6÷100; 7÷210; 8÷350		
Max pressure [bar]	ports P, X = 350 Ports T, Y = 210 (without pilot solenoid valve) For version with pilot solenoid valve, see technical tables E010 and E015		
Max flow [l/min]	200	400	600

4 MAIN CHARACTERISTICS, SEALS AND FLUIDS - for other fluids not included in below table, consult our technical office

Assembly position	Any position		
Subplate surface finishing	Roughness index Ra 0,4 - flatness ratio 0,01/100 (ISO 1101)		
Compliance	CE to Low Voltage Directive 2014/35/EU RoHS Directive 2011/65/EU as last update by 2015/65/EU REACH Regulation (EC) n°1907/2006		
Ambient temperature	Standard execution = -30°C ÷ +70°C /PE option = -20°C ÷ +70°C /BT option = -40°C ÷ +70°C		
Seals, recommended fluid temperature	NBR seals (standard) = -20°C ÷ +80°C, with HFC hydraulic fluids = -20°C ÷ +50°C FKM seals (/PE option) = -20°C ÷ +80°C HNBR seals (/BT option) = -40°C ÷ +60°C, with HFC hydraulic fluids = -40°C ÷ +50°C		
Recommended viscosity	15÷100 mm ² /s - max allowed range 2,8 ÷ 500 mm ² /s		
Max fluid contamination level	ISO4406 class 20/18/15 NAS1638 class 9, see also filter section at www.atos.com or KTF catalog		
Hydraulic fluid	Suitable seals type	Classification	Ref. Standard
Mineral oils	NBR, FKM, HNBR	HL, HLP, HLPD, HVLP, HVLPD	DIN 51524
Flame resistant without water	FKM	HFDR, HFDR	ISO 12922
Flame resistant with water	NBR, HNBR	HFC	

4.1 Coils characteristics (for AGAM with pilot solenoid valve)

Insulation class	DHI pilot	H (180°C)	Due to the occurring surface temperatures of the solenoid coils, the European standards EN ISO 13732-1 and EN ISO 4413 must be taken into account
	DHE pilot	H (180°C) for DC coils F (155°C) for AC coils	
Protection degree to DIN EN 60529	IP 65 (with connectors 666, 667, 669 or E-SD correctly assembled)		
Relative duty factor	100%		
Supply voltage and frequency	See electric feature <input checked="" type="checkbox"/>		
Supply voltage tolerance	± 10%		
Certification	cURus North American standard		

5 OPTIONS

- /E = external pilot
- /V = regulating handwheel instead of grub screw protected by cap (for handwheel features, see table K150)
- /WP = prolonged manual override protected by rubber cap (only for AGAM with pilot solenoid valve)
- /Y = external drain (only for AGAM with pilot solenoid valve)

6 ELECTRIC CONNECTORS ACCORDING TO DIN 43650 FOR AGAM WITH SOLENOID VALVE

The connectors must be ordered separately

Code of connector	Function
666	Connector IP-65, suitable for direct connection to electric supply source
667	As 666 connector IP-65 but with built-in signal led, suitable for direct connection to electric supply source

For other available connectors, see tab. E010 and K500

7 ELECTRIC FEATURES FOR AGAM WITH SOLENOID VALVE

Solenoid valve type	External supply nominal voltage $\pm 10\%$ (1)		Voltage code	Type of connector	Power consumption (3)		Code of spare coil DHI	Colour of coil label DHI	Code of spare coil DHE
					DHI	DHE			
DHI DHE	DC	12 DC 24 DC 110 DC 220 DC	12 DC 24 DC 110 DC 220 DC	666 or 667	33 W	30 W	COU-12DC COU-24DC COU-110DC COU-220DC	green red black black	COE-12DC COE-24DC COE-110DC COE-220DC
		AC	110/50 AC (2) 115/60 AC 120/60 AC 230/50 AC (2) 230/60 AC	110/50/60 AC 115/60 AC (5) 120/60 AC (6) 230/50/60 AC 230/60 AC	666 or 667	60 VA - 60 VA 60 VA 60 VA	58 VA 80 VA - 58 VA 80 VA	COI-110/50/60AC - COI-120/60AC COI-230/50/60AC COI-230/60AC	yellow - white light blue silver

(1) For other supply voltages available on request see technical tables E010, E015.

(2) Coil can be supplied also with 60 Hz of voltage frequency; in this case the performances are reduced by 10 ÷ 15% and the power consumption is 55 VA (DHI) and 58 VA

(3) Average values based on tests performed at nominal hydraulic condition and ambient/coil temperature of 20°C.

(4) When AC solenoid is energized, the inrush current is approx 3 times the holding current.

(5) Only for DHE

(6) Only for DHI

8 REGULATED PRESSURE VERSUS FLOW DIAGRAMS based on mineral oil ISO VG 46 at 50°C

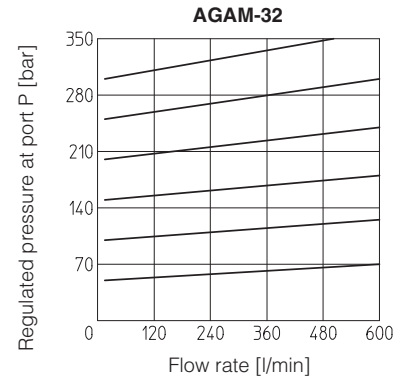
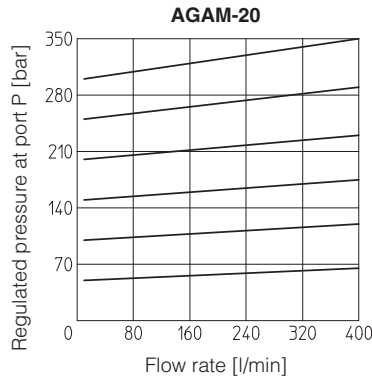
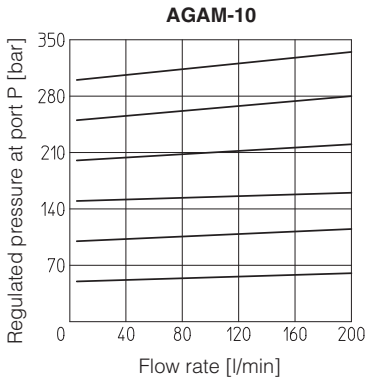

9 PERMISSIBLE RANGE (shared area) based on mineral oil ISO VG 46 at 50°C

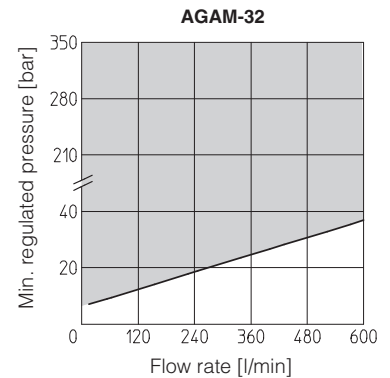
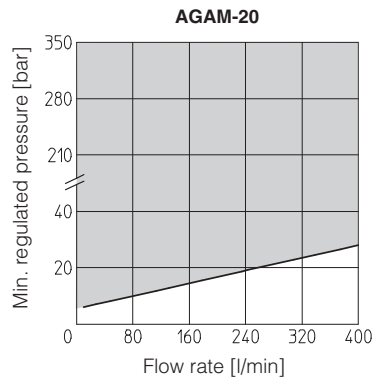
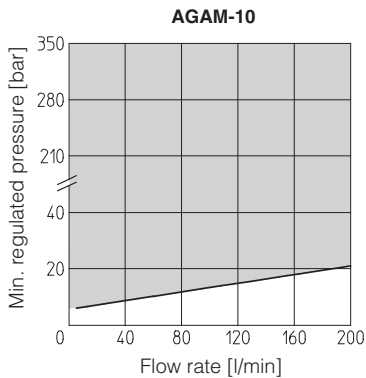

10 MINIMUM PRESSURE VERSUS FLOW DIAGRAMS based on mineral oil ISO VG 46 at 50°C

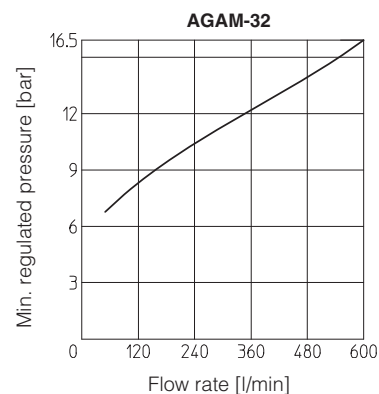
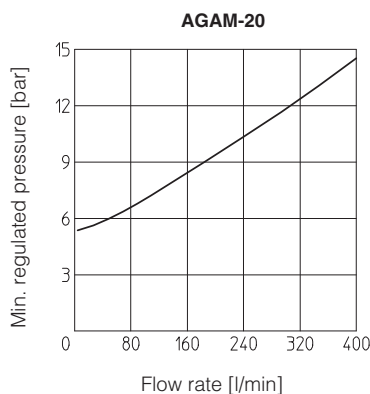
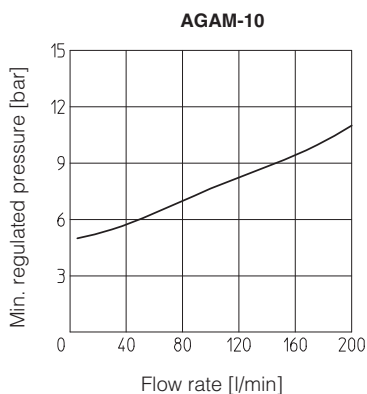

11 DIMENSIONS [mm]

AGAM-10

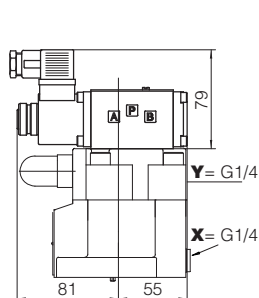
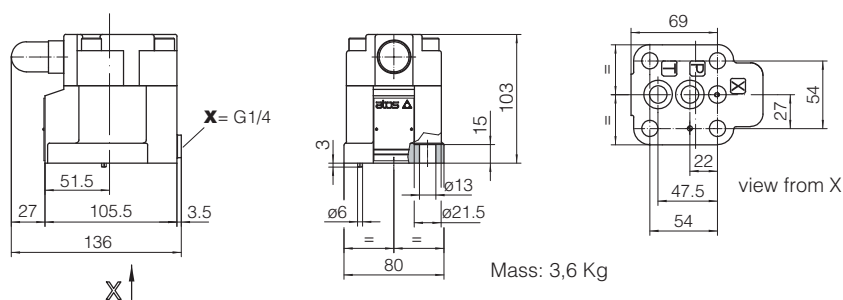

AGAM-10/10/-IX**
AGAM-10/11/-IX**
 Mass: 5,1 Kg

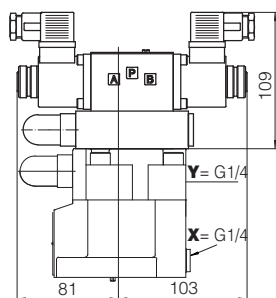

AGAM-10/20/-IX**
AGAM-10/21/-IX**
 Mass: 6,2 Kg

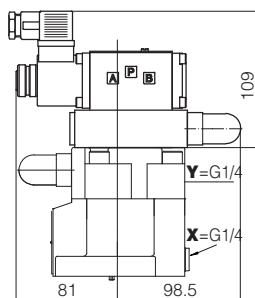

AGAM-10/22/-IX**
 Mass: 5,9 Kg

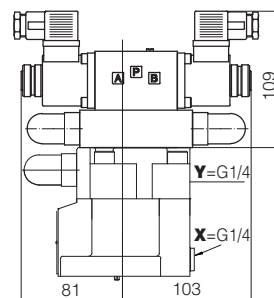

AGAM-10/32/-IX**
 Mass: 6,3 Kg

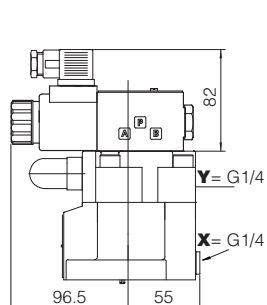

AGAM-10/10/-EX**
AGAM-10/11/-EX**
 Mass: 5,1 Kg

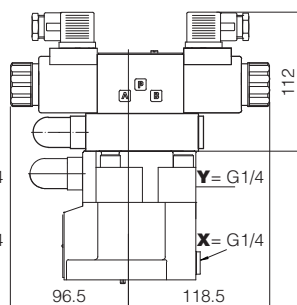

AGAM-10/20/-EX**
AGAM-10/21/-EX**
 Mass: 6,2 Kg

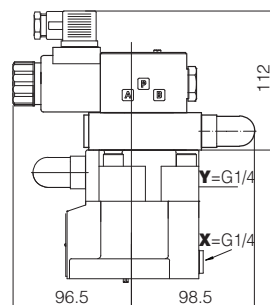

AGAM-10/22/-EX**
 Mass: 5,9 Kg

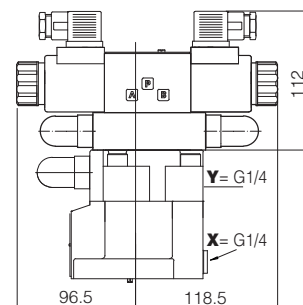

AGAM-10/32/-EX**
 Mass: 6,3 Kg

AGAM-20

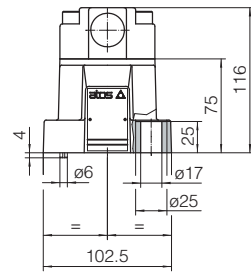
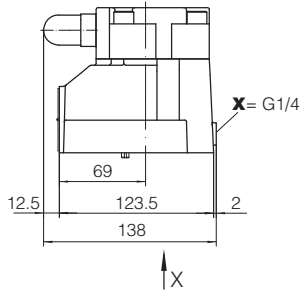

Mass: 4,8Kg

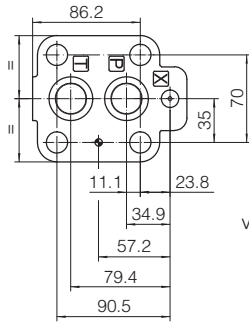

view from X

ISO 6264: 2007

Mounting surface: 6264-08-11-1-97

Fastening bolts:

4 socket head screws M16x50 class 12.9

Tightening torque = 300 Nm

Seals: 2 OR 4112; 1 OR 109/70

Ports P, T: $\phi = 24$ mm

Ports X: $\phi = 3,2$ mm

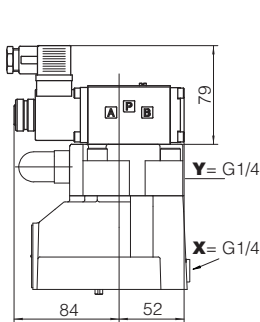

AGAM-20/10/-IX**
AGAM-20/11/-IX**

Mass: 6,3 Kg

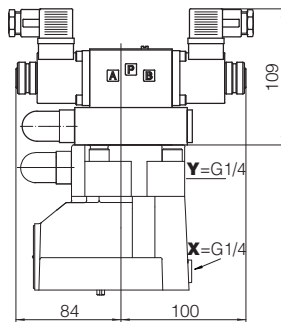

AGAM-20/20/-IX**
AGAM-20/21/-IX**

Mass: 7,4Kg

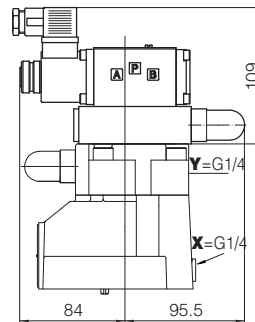

AGAM-20/22/-IX**

Mass: 7,1 Kg

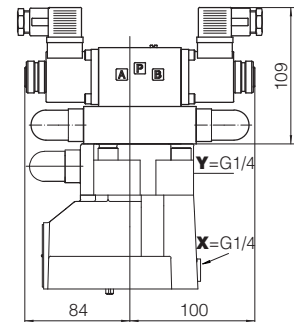

AGAM-20/32/-IX**

Mass: 7,5 Kg

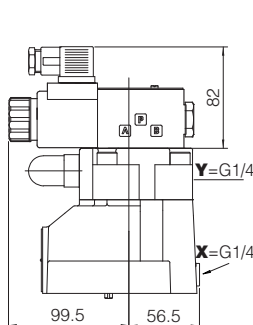

AGAM-20/10/-EX**
AGAM-20/11/-EX**

Mass: 6,3 Kg

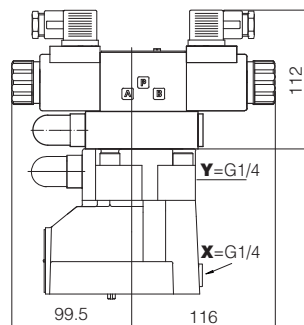

AGAM-20/20/-EX**
AGAM-20/21/-EX**

Mass: 7,4 Kg

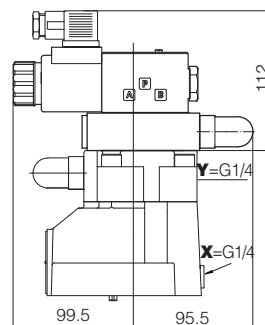

AGAM-20/22/-EX**

Mass: 7,1 Kg

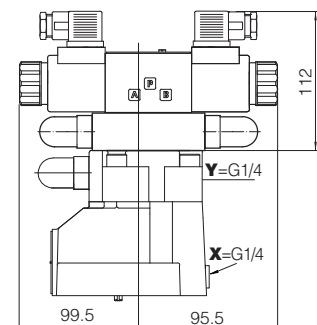

AGAM-20/32/-EX**

Mass: 7,5 Kg

Overall dimensions refer to valves with connectors type 666

AGAM-32

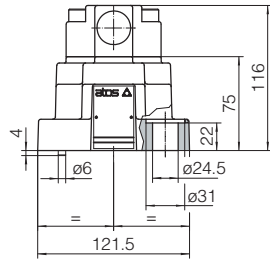
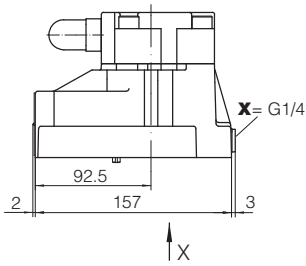

Mass: 6,2 Kg

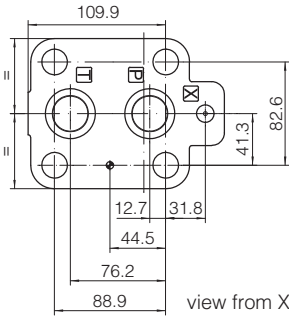

ISO 6264: 2007

Mounting surface: 6264-10-17-1-97
(with M20 fixing holes instead of standard M18)

Fastening bolts:

4 socket head screws

M20x60 class 12.9

Tightening torque = 600 Nm

Seals: 2 OR 4131; 1 OR 109/70

Ports P, T: $\varnothing = 28,5$ mm

Ports X: $\varnothing = 3,2$ mm

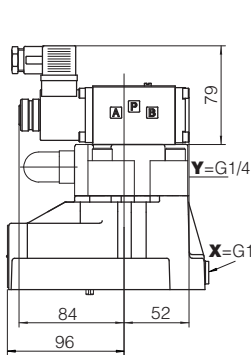

AGAM-32/10/**-IX
AGAM-32/11/**-IX
Mass: 7,7 Kg

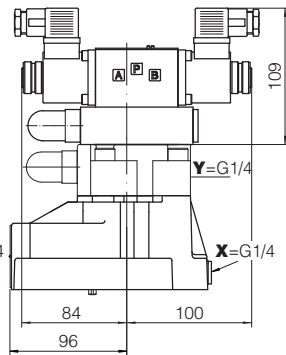

AGAM-32/20/**-IX
AGAM-32/21/**-IX
Mass: 8,8 Kg

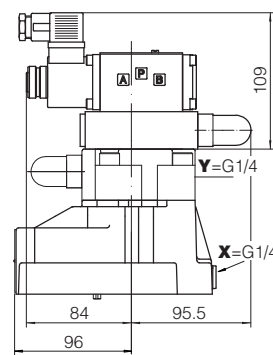

AGAM-32/22/**-IX
Mass: 8,5 Kg

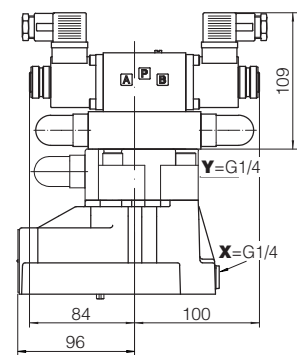

AGAM-32/32/**-IX
Mass: 8,9 Kg

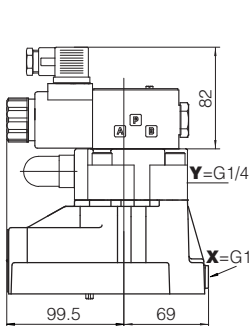

AGAM-32/10/**-EX
AGAM-32/11/**-EX
Mass: 7,7 Kg

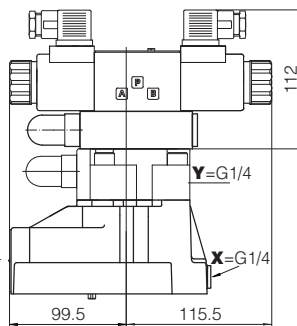

AGAM-32/20/**-EX
AGAM-32/21/**-EX
Mass: 8,8 Kg

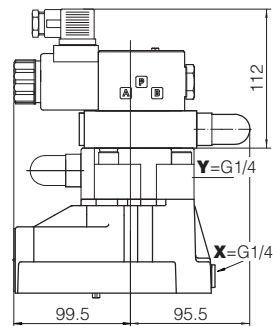

AGAM-32/22/**-EX
Mass: 8,5 Kg

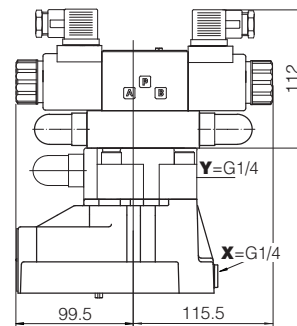

AGAM-32/32/**-EX
Mass: 8,9 Kg

Overall dimensions refer to valves with connectors type 666

12 MOUNTING SUBPLATES

Valve	Subplate model	Port location	Ports			Ø Counterbore [mm]			Mass [Kg]
			P	T	X	P	T	X	
AGAM-10	BA-306	Ports P, T, X underneath;	G 1/2"	G 3/4"	G 1/4"	30	36,5	21,5	1,5
AGAM-20	BA-406		G 3/4"	G 3/4"	G 1/4"	36,5	36,5	21,5	3,5
	BA-506		G 1"	G 1"	G 1/4"	46	46	21,5	3,5
AGAM-32	BA-706		G 1 1/2"	G 1 1/2"	G 1/4"	63,5	63,5	21,5	6

The subplates are supplied with fastening bolts. For further details see table K280